

**DISCLAIMER**

Unit must be installed by a competent electrician or electrical engineer. Failure to comply with these instructions could invalidate your warranty.

This V11M BPC unit is supplied already wired. There is no need to disconnect any wires. Follow these instructions carefully and refer to the wiring diagram.

IT IS RECOMMENDED THAT YOUR V11M IS FITTED AGAINST A WALL OR SIMILAR VERTICAL SURFACE.

1. Ensure the V11M is NOT PLUGGED into the MAINS SUPPLY.
2. Remove the top cover by loosening the four corner screws. Using a large pozidrive screw driver continuously turn clockwise.
3. Carefully remove top cover.
4. Screw unit to the wall or vertical surface through the four ready drilled holes in the corners of the back box.
5. Carefully replace the top cover and tighten the four corner screws using the reverse procedure to instruction 2 above.

You are now ready to control your pump.

Specification	Value
Supply Voltage	85 - 264 VAC
Fuse Rating	5A
Max Switched Load	1000VA
Enclosure Material	ABS
Water Resistance	IP56
Dimensions	201 x 163 x 150 (mm)
Working Temperature	0 to 40 Deg C

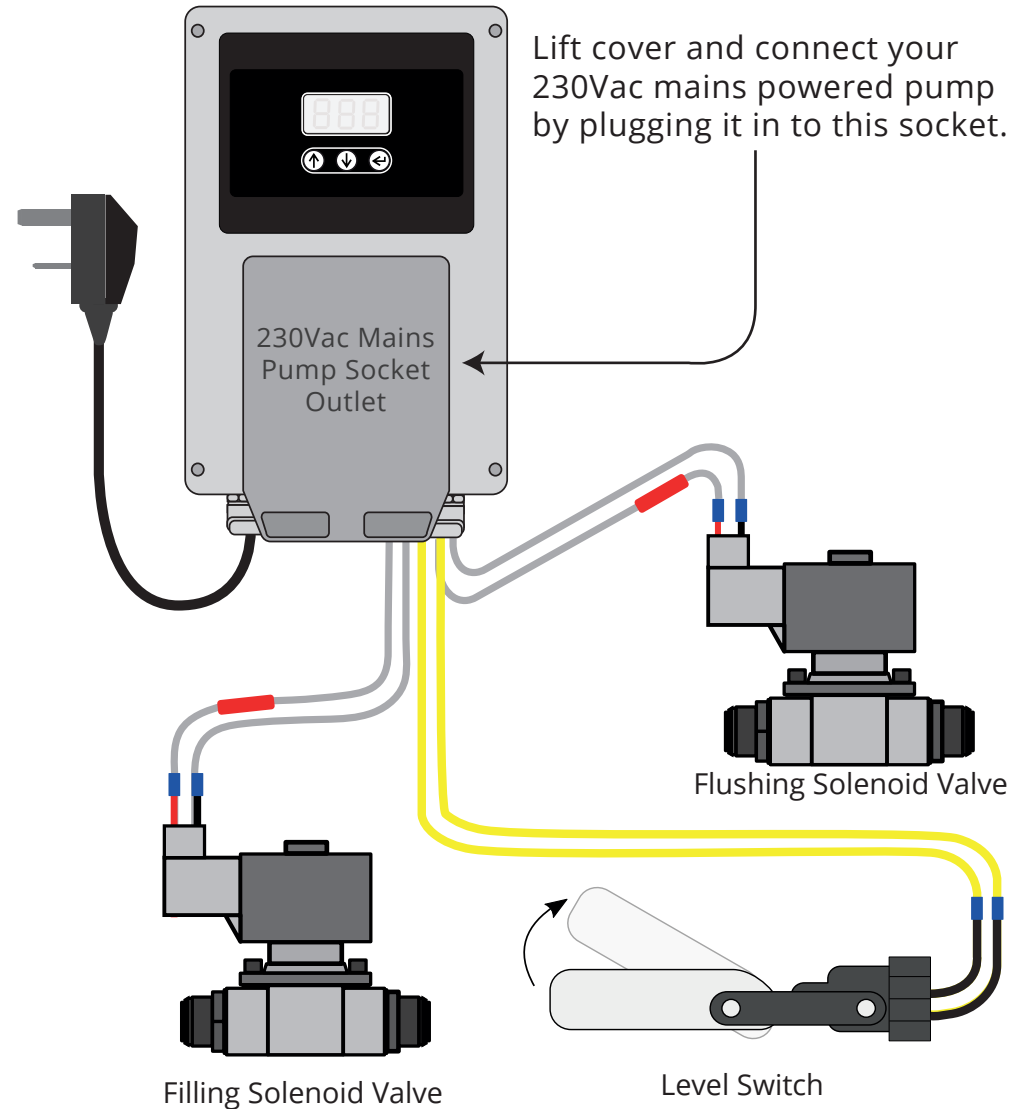

Connect the pump controller in accordance with this diagram and the fitting instructions.



**ALWAYS DISCONNECT THE MAINS SUPPLY BEFORE OPENING UNIT.**  
**ALWAYS DISCONNECT THE MAINS SUPPLY BEFORE CONNECTING THE PUMP.**

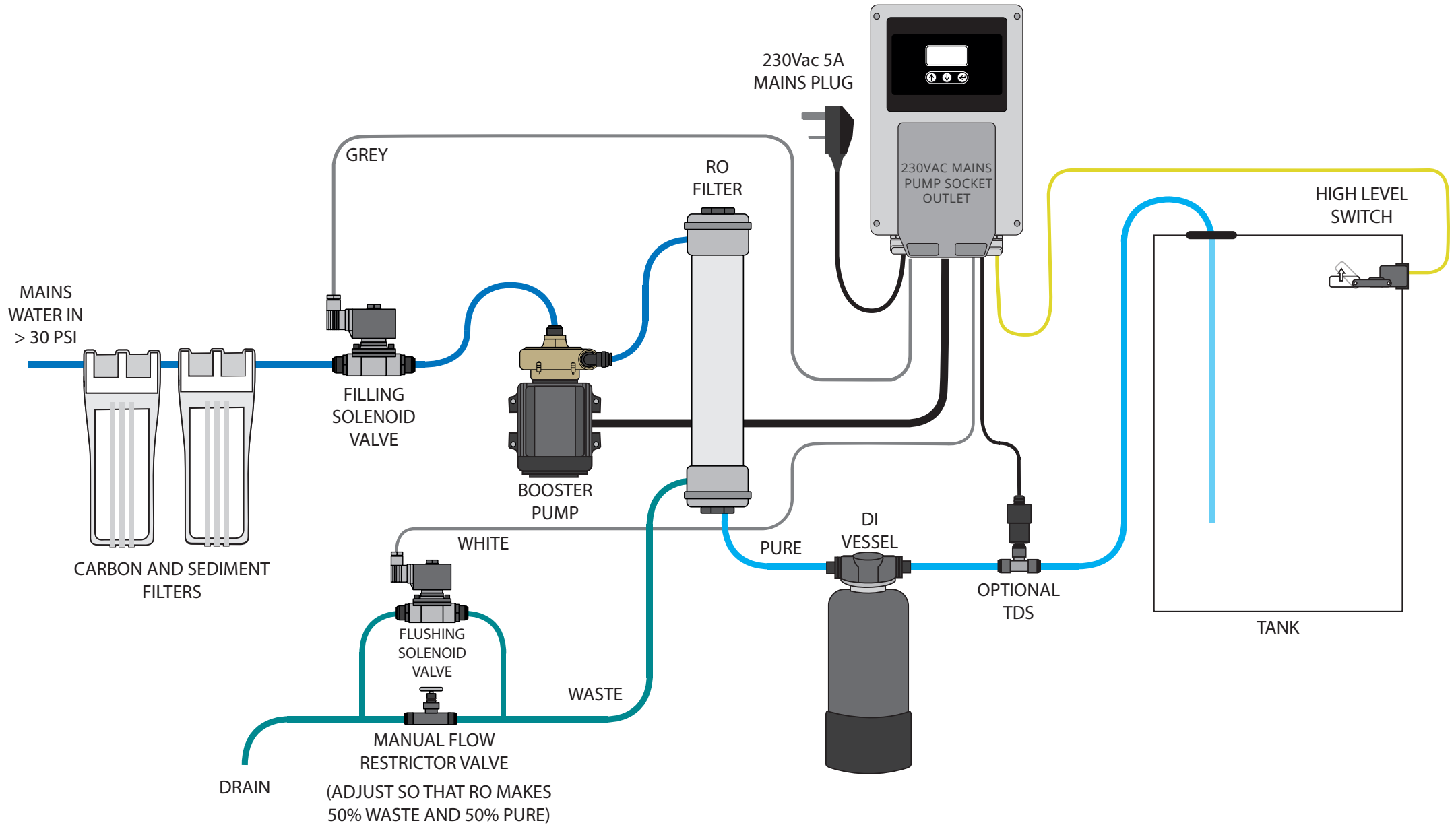

 **ALWAYS DISCONNECT THE MAINS SUPPLY BEFORE OPENING UNIT.**  
**ALWAYS DISCONNECT THE MAINS SUPPLY BEFORE CONNECTING THE PUMP.**

**DISCLAIMER!**  
 Unit must be installed by a competent electrician or electrical engineer. Failure to comply with these instructions could invalidate your warranty.

Connect your pump and liquid system to be controlled.

Turn on the controller by pressing the up or down button. Keep the button held until the display lights up.

On first power up the controller shows the following display. This is the default power up display and indicates the unit has power.



If your V11M is configured as a 'Fill on Demand' unit then filling will start automatically as soon as the level switch is in the down (normally closed) position.



If your V11M is configured as a 'One time fill' unit then filling will start when you press and hold the up and down buttons together.



The controller will turn on the filling solenoid valve and then turns on the booster pump to fill your tank. While filling the controller will display 'FIL'.

If the unit is a 'One time fill' then pressing the up and down buttons together and holding will stop the fill.



When the tank is full enough to activate the level switch, the controller will stop the fill by stopping the booster pump and closing the filling solenoid valve. The controller will go back to displaying the standby pattern.

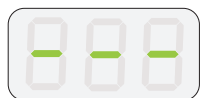

If configured, your controller can have two filling modes:

1. One time fill (stops when the level switch activates/lifts)
2. Fill on demand (refills every time the level switch drops)

To select the required filling mode press and hold the down and enter buttons. The controller will display the fill on demand (FOD) menu.

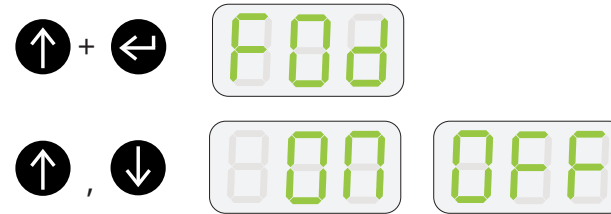

Press up or down to change between on and off. Off will set the controller to 'one time fill'. On will set the controller to 'fill on demand'.

Press enter to set. The next setting is Fill Delay.



Fdy is the time delay in minutes from the tank reaching full and the filling re-starting should the water level drop. You can set this delay from 0-10 minutes with the up and down buttons. Setting to '0' turns the delay off. Press enter to set. This setting only affects Fill on demand.

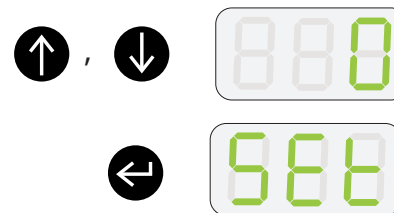

#### DISCLAIMER

THE MANUFACTURER RESERVES THE RIGHT TO MAKE CHANGES TO ANY PRODUCT HEREIN TO IMPROVE RELIABILITY, FUNCTION OR DESIGN. THE MANUFACTURER DOES NOT ASSUME ANY LIABILITY ARISING OUT OF THE APPLICATION OR USE OF ANY PRODUCT OR CIRCUIT DESCRIBED HEREIN.

For more information and videos on how to use Spring controllers please visit: [www.springltd.co](http://www.springltd.co)

The next setting (if configured) is Autoflush. Your controller has three Autoflush modes:

- 0 - Autoflush is off
- 1 - Repeat Autoflush every hour
- 2 - Autoflush just once at the start of filling

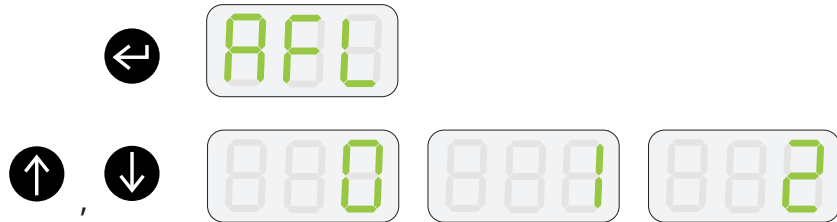

Select the required Autoflush mode with the up or down button. Then press enter to set. Note; if you do not have a flushing solenoid valve in your system, set AFL to '0'.